

WS8 Series Wall Module

For use with fan coil units

Product Data



Application

WS8 Series wall modules are designed for indoor temperature control. It has large LCD display providing real time display of room temperature or set temperature. With temperature set, it will provide on/off control signal to the fan coil valve for temperature regulation to the occupant's desired comfort. WS8 Series wall modules provide selectable automatic or manual control of fan speeds. It also provides anti-freeze function.

Key Features

- Extra-large LCD display and operating interface
- Temperature display selection (room temperature or set temperature)
- Manual or automatic fan speed selection
- Anti-freeze protection
- Operating buttons lock/unlock
- Temperature range setting
- Standard 86 wall-mounted installation box

Technical Specification

- Operating voltage: 100VAC-240VAC 50-60Hz
- Load capacity: Resistive – Fan unit 3A; valve 2A
Inductive – Fan unit 1A; valve 0.6A
- Protection rating: IP20
- Temperature setting range: 10~30°C
50~86°F
- Temperature display range: -10~50°C
14~99°F
- Operating temperature:
-30~60°C
-22~140°F
- Relative humidity: 5-90%RH, non condensating

Ordering Part Numbers

Part Number	Operating Voltage	Application	Backlight	Ventilation Mode
WS8B2WB/U	100-240Vac	2-pipe	White	Yes
WS8B4WB/U	100-240Vac	2/4-pipe	White	Yes

Product Details

Outlook design



LCD Screen

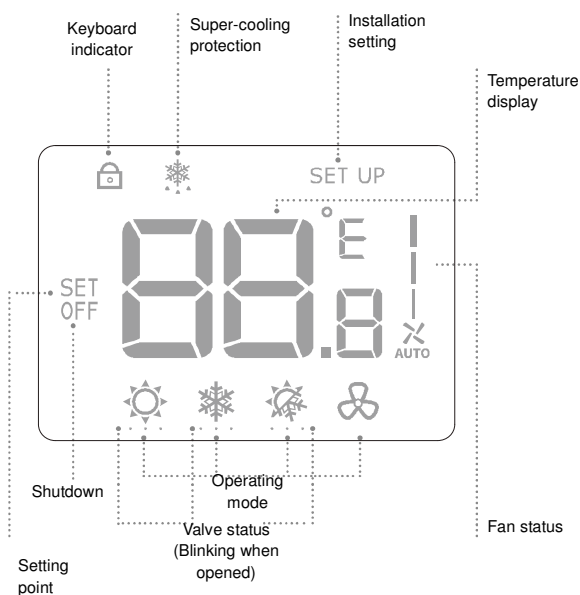

Functions

Valve and Fan Control

The wall module reads indoor temperature through integrated temperature sensor and command valve to be opened or closed to achieve set temperature. There are three fan speeds which can be set manually or automatically. Under manual mode, fan speed is adjusted by FH, FM and FL outputs. Under automatic mode, the fan speed will depend on the difference between the room temperature and set temperature. The fan will shut down when the valve is not operating.

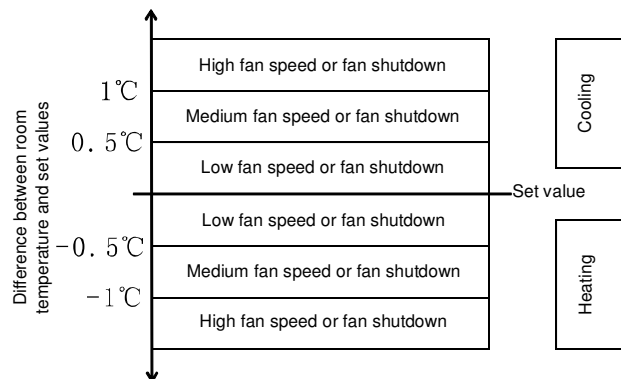

Figure 1 Automatic fan speed control algorithm

Temperature display

Room temperature or set temperature can be set to be displayed during the installation of the wall module.

Backlight

The backlight can be activated by pressing any button and will last for 8 seconds upon the last button pressed. Under setting mode, the backlight will remain on for 60 seconds after pressing the last button.

Keypad lockout

It is possible to lock or unlock the keypad while the device is not in setting mode. Under the lock mode, the keypad will be inactive when pressing any button.

Dimensions (mm)

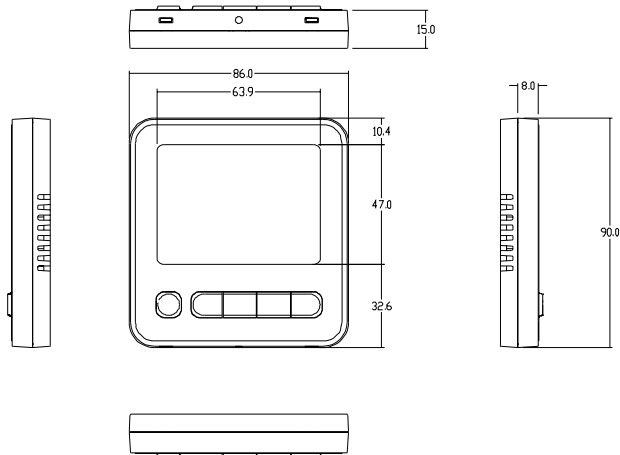

Operation modes

Press “mode” button to select heating, cooling, automatic or ventilation modes

Comfort mode

In comfort mode, press the Up or Down button to set the temperature. The comfort mode is included in individual cooling, individual heating, and manual operation of cooling/heating interchange.

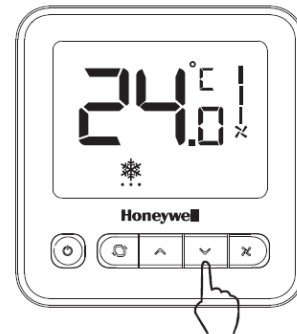

Ventilation mode

In ventilation mode, the fan will operate on the manually set fan speed. The valve stops.

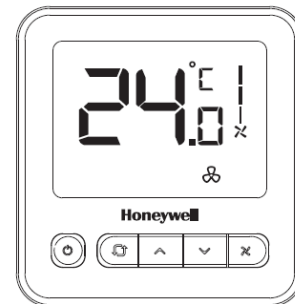

Anti-freeze mode

Anti-freeze mode is an option under the heating mode. When selected, if room temperature falls below 6C, the wall module (in off status) will be activated in heating mode until it reaches 8C.

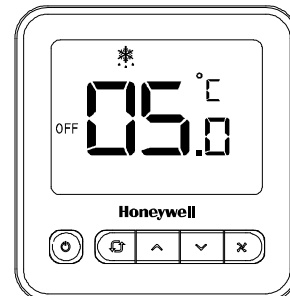

Product Wiring Diagram

Part number: WS8B2WB/U

2-pipe Application

Wiring diagram 1

2-wire motorized valve

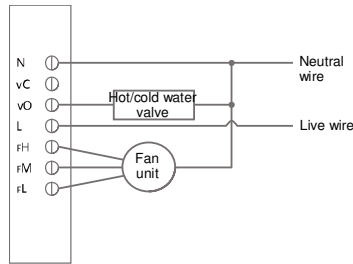

Wiring diagram 2

3-wire motorized valve

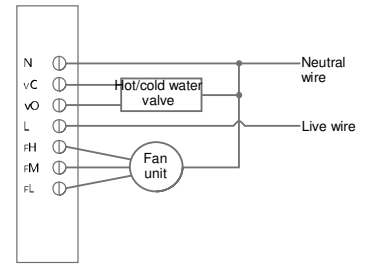

Part number: WS8B4WB/U

2-pipe Application

Wiring diagram 1

2-wire motorized valve

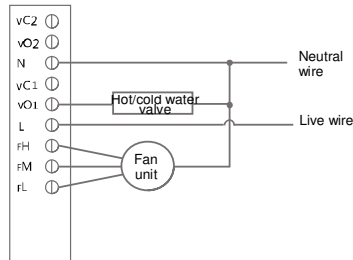

Wiring diagram 2

3-wire motorized valve

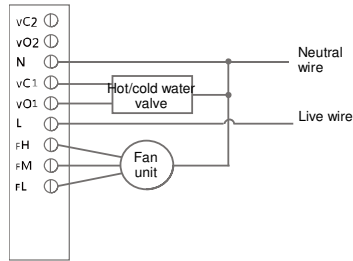

4-pipe Application

Wiring diagram 1

2-wire motorized valve

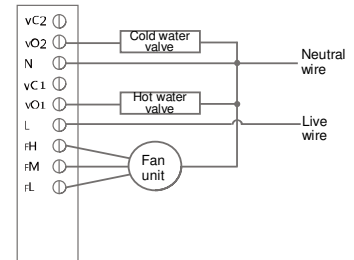

Wiring diagram 2

3-wire motorized valve

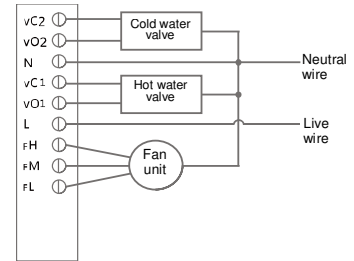

Definition of Terminals

Symbols	Description
vC2	Cooling valve is closed (for quadruple-pipe only)
vO2	Cooling valve is open (for quadruple-pipe only)
N	Power source neutral wire
vC1	Heating/cooling valve is closed
vO1	Heating/cooling valve is open
L	Power source live wire
rH	High fan speed
rM	Medium fan speed
rL	Low fan speed

Troubleshooting

Malfunction	Action
☀ Fails to activate	Press to change the operating mode to "☀" (heating mode) Check if the set temperature is higher than current indoor temperature Check if the valve status indicator light is blinking Check if the heating system is responding after 5 minutes
❄ Fails to activate	Press to change the operating mode to "❄" (cooling mode) Check if the set temperature is lower than current indoor temperature Check if the valve status indicator light is blinking Check if the cooling system is responding after 5 minutes
🔁 Fails to work	Check if the button is locked Check if the device is in OFF mode
⏸ Fails to work	Check if the button is locked Check if the device is in mode Check if the device is in OFF mode